

# OQ Open Stack Series 8 kW Regulated High Voltage DC Power Supplies

200 kV to 500 kV  
CE Compliant

Parallelable up to  
40 kW

Fully RoHS  
Compliant

The OQ open stack family are sophisticated 8 kW power supplies with extremely low ripple and noise. They are air insulated fast response units with tight regulation

Please refer to Technology > Applications page on our web site for typical applications.

The OQ Series are fully compliant with the following European Directives:

- EN61010/ IEC61010, Safety
- EN61000-6-4, Conducted and Radiated Emissions
- EN61000-6-2:2005, Conducted and Radiated Immunity
- 2011/65/EU, Restriction of the use of Hazardous Substances (RoHS)

CE (Meets all applicable directives), UKCA (Meets all applicable legislation)

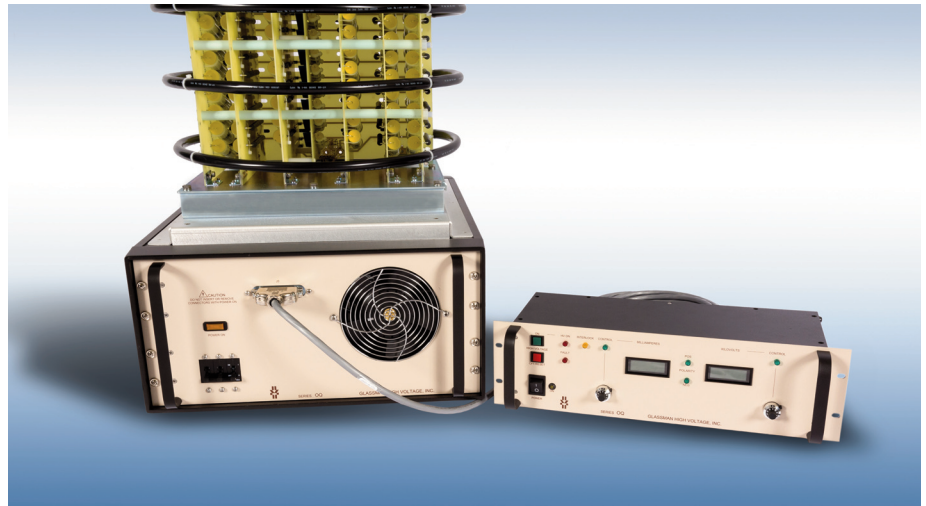

Models from 0 to 200 kV through 0 to 500 kV. 8 kW system shown above (and bottom left).

OQ open stack series models consist of a rack style driver chassis, a high voltage stack assembly, and a remote control unit. The driver chassis is provided in a cabinet which is 10.86" H X 19.75" W X 25.06" D. The remote control unit is 5.218" H X 19.00" W X 6.625" D.

## Features:

**Arc Quench.** The HV output is inhibited for a short period after each load arc to help extinguish the arc.

**Arc Count.** Internal circuitry constantly senses and integrates arcs that occur over a given time. In the event that a load arcing problem develops, the power supply will cycle off, then automatically restart.

**Embedded Microcontroller Control.** Integral RS-232, USB and optional Ethernet communications provide remote control program and monitor.

**Air Insulated.** The OQ Series features "air" as the primary dielectric medium. No oil or encapsulation is used to impede serviceability, or increase weight.

**Input Voltage.** 208 VAC standard. 380, 415 & 480 VAC optional

**Low Ripple.** Typically, ripple is less than 0.1% peak to peak of rated voltage at full load.

**Parallelable.** One master supply and up to 4 slave supplies provide a maximum of 25 - 40 kW depending on kV.

**Pulse-Width Modulation.** Off-the-line pulse-width modulation provides high efficiency and a reduced parts count for improved reliability.

**Constant Voltage/Constant Current Operation.** Automatic crossover from constant-voltage to constant-current regulation provides protection against overloads, arcs, and short circuits.

**Constant Current/Current Trip.** A rear panel selector switch on the remote chassis allows selection of either current mode.

**Tight Regulation.** Voltage regulation is better than 0.005% for allowable line and load variations. Current regulation is better than 0.1% from short circuit to rated voltage.

**Warranty.** All power supplies are warranted for three years. A formal warranty statement is available..

## Specifications

Specifications apply from 5% to 100% rated voltage. (Operation is guaranteed down to zero voltage with a slight degradation of performance.)

**Input:** 187-228 V RMS, 3 $\phi$ , 48-63 Hz, 13 kVA maximum at full load. Less than 40A/ $\phi$  at 208 VAC. A five position terminal block with protective cover is provided. **Mains service must be protected with fuses or circuit breakers with a maximum rating of 125 A for 208 VAC models & 100 A for 380 through 480 VAC models.**

**Efficiency:** Typically 80% at full load.

**Output:** Continuous stable adjustment from 0 to rated voltage or current by panel mounted 10-turn potentiometers with 0.05% resolution, or by external 0 to 10 V signals is provided. Repeatability better than 0.1% of setting. Voltage accuracy is 0.5% of setting + 0.2% of rated.

**Static Voltage Regulation:** Better than +/- 0.005% for specified line variations and 0.005% for no load to full load variations.

**Current Regulation:** Better than 0.1% from short circuit to rated voltage at any load condition, when in current regulation mode.

When in current trip mode the HV output will disable and latch off when the load current reaches the programmed current level. Reset is accomplished by either cycling the AC power or HV ON/OFF buttons or by toggling the HV enable signal. A switch located on the rear panel of the remote control chassis allows the selection of current limit or current trip operation.

**Voltage monitor:** 0 to 10V equivalent to 0 to rated voltage. Accuracy, 0.5% of reading + 0.2% of rated. Impedance is 10 K $\Omega$ .

**Current monitor:** 0 to 10V equivalent to 0 to rated current. Accuracy, 1% of reading + 0.1% of rated. Impedance is 10 K $\Omega$ .

**Stored Energy:** Stored energy varies with output voltage and is tabulated in the models chart.

**Ripple:** Ripple consists of two major components, inverter switching frequency components and line frequency related components. The

inverter frequency component is dependent on the amount of load current drawn. The line frequency related component is determined by the amount of power delivered to the load. The maximum values for both components are specified in the models chart.

**Stability:** 0.01% per hour after 1/2 hour warm-up, 0.05% per 8 hours.

### Voltage Rise/Decay Time

**Constant:** 400 ms typical using either the HV ON switch or remote programming with a minimum 4.8 mA resistive load.

**Temperature Coefficient:** 0.01%/°C.

**Ambient Temperature:** -20 to +40° C, operating, -40 to +85° C storage.

**Protection:** Automatic current regulation protects against all overloads, including arcs and short circuits.

Thermal switches and RPM sensing fans protect against thermal overload. Fuses, surge-limiting resistors and low energy components provide ultimate protection.

**Arc Quench:** An arc quench feature provides sensing of each load arc and quickly inhibits the HV output for approximately 0.25 seconds after each arc.

**Arc Count:** Internal circuitry senses the number of arcs caused by external load discharges. If the rate of consecutive arcs exceeds approximately one arc per second for 5 arcs, the supply will turn off for approximately 5 seconds to allow clearance of the fault. After this period the supply will automatically return to the programmed kV value with the rise time constant indicated. If the load fault still exists the above cycle will repeat.

### RS232/USB/Ethernet Programming and Monitor Accuracy:

**Resolution:** 0.025% of full scale for both the voltage and the current programs. 0.1% of full scale for both the voltage and the current monitors.

**Remote setting accuracy:** Voltage setting accuracy is better than 0.5% of setting + 0.2% of rated.

### Remote reading accuracy:

Voltage reading accuracy is 0.5% of reading + 0.2% of rated. Current reading accuracy is 1% of reading + 0.1% of rated.

**Remote Control Unit:** A separate control panel chassis is provided which contains all the control functions.

The front panel of this assembly contains: separate 10-turn controls with locking vernier dials used to set the voltage and current levels, High Voltage ON switch, High voltage OFF/Reset switch and an AC power on/off switch and indicator. LED's indicate when the high voltage is on, output polarity, interlock status, fault status, and whether the supply is operating in a voltage or current regulating mode. Output levels are indicated by voltage and current digital meters.

The rear panel of this assembly contains: AC Power On indicator, ground stud, driver/control chassis interface connectors, current limit/current trip selector switch, remote user interface connector and RS232/USB connectors.

The signals provided on the remote user interface connector are as follows:

**Inputs:** Output voltage and current program signals, and high voltage enable.

**Outputs:** Output voltage and current monitor signals, a +10V reference source, a high voltage status signal, fault status, and V/I mode status.

Signal common and ground reference terminals are also provided.

**Remote HV Enable:** 0 - 1.5V = OFF, 2.5 - 15V = ON.

**External Interlock:** Open = off, closed = on. Latching with reset via the HV ON switch. The front panel indicator is illuminated when the interlock is open. Interlock connections are provided on a terminal strip on the rear panel of the driver chassis.

**Accessories:** 25 feet of detachable interconnection cables, a 10 foot null modem cable, and a 10 foot USB cable are provided.

## Options

### Symbol Description

200	180-220 VRMS, 3Ø input, 48-63 Hz.
380	342-440 VRMS, 3Ø input, 48-63 Hz.
415-50	370-460 VRMS, 3Ø input, 48-52 Hz.
480-60	430-530 VRMS, 3Ø input, 57-63 Hz.
ZR	Zero start Interlock. Voltage control, local or remote, must be zero before HV will enable.
SS	Slow start ramp. Specify standard times of 5, 10, 15, 20, or 30 seconds + 20%.
5VC	0-5 V voltage and current program/monitor.
ETH	Virtual RS-232 COM port over Ethernet network. (Requires compatible OS (eg Windows) for COM drivers)

Please consult factory for special requirements.

## 8 kW Models

Positive Polarity	Negative Polarity	Reversible Polarity	Output Voltage	Output Current	Max Stored Energy (J)	High Freq. Ripple (P-P)	Line Freq. Ripple (P-P)
OQ200P40	OQ200N40	OQ200R40	0-200 kV	0-40 mA	198	210	20
OQ250P32	OQ250N32	OQ250R32	0-250 kV	0-32 mA	232	220	20
OQ300P25	OQ300N25	OQ300R25	0-300 kV	0-25 mA	286	200	20
OQ350P18	OQ350N18	OQ350R18	0-350 kV	0-18 mA	321	175	20
OQ400P14	OQ400N14	OQ400R14	0-400 kV	0-14 mA	375	155	20
OQ450P12	OQ450N12	OQ450R12	0-450 kV	0-12 mA	429	145	20
OQ500P10	OQ500N10	OQ500R10	0-500 kV	0-10 mA	464	140	20

## 16 kW Models

Positive Polarity	Negative Polarity	Reversible Polarity	Output Voltage	Output Current	Max Stored Energy (J)	High Freq. Ripple (P-P)	Line Freq. Ripple (P-P)
OQ200P80	OQ200N80	OQ200R80	0-200 kV	0-80 mA	396	210	20
OQ250P64	OQ250N64	OQ250R64	0-250 kV	0-64 mA	464	220	20
OQ300P50	OQ300N50	OQ300R50	0-300 kV	0-50 mA	572	200	20
OQ350P36	OQ350N36	OQ350R36	0-350 kV	0-36 mA	642	175	20
OQ400P28	OQ400N28	OQ400R28	0-400 kV	0-28 mA	750	155	20
OQ450P24	OQ450N24	OQ450R24	0-450 kV	0-24 mA	858	145	20
OQ500P20	OQ500N20	OQ500R20	0-500 kV	0-20 mA	928	140	20

For Models Greater Than 16 kW, Please Consult Factory.

# High Voltage Stack Assembly

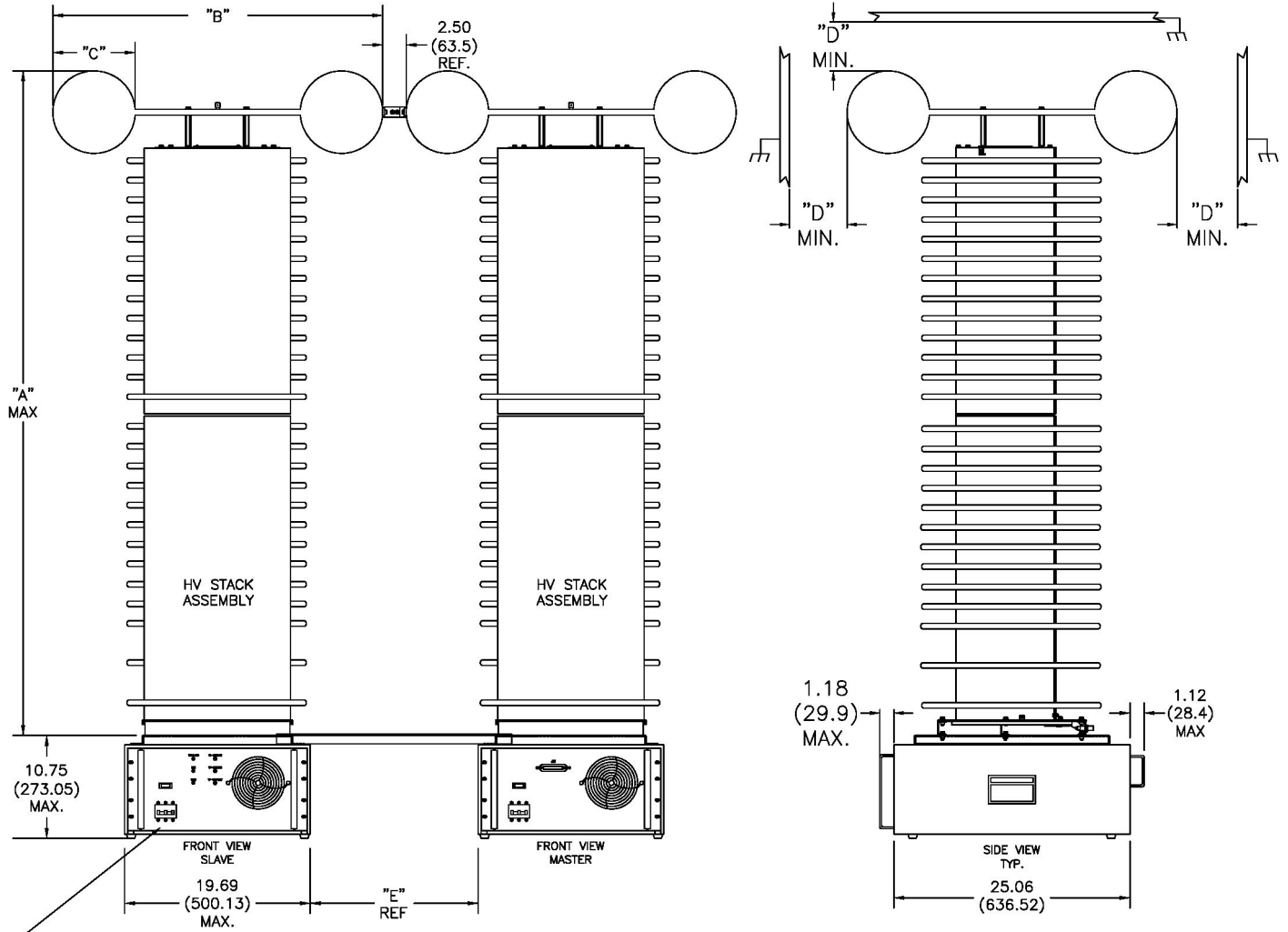

STACK DIMENSIONS (NOMINAL)

RECOMMENDED MINIMUM CLEARANCE

SIZE KV	"A"	"B"	"C"	"D"	"E"
200KV	30.00 (762)	24.00 (610)	5.00 (127)	24 (610)	6.81 (172.97)
250KV	37.30 (947.42)	28.00 (711)	7.00 (178)	31 (787)	10.81 (274.57)
300KV	41.50 (1054.10)	28.00 (711)	7.00 (178)	38 (965)	10.81 (274.57)
350KV	53.75 (1365.25)	34.00 (864)	8.50 (216)	45 (1143)	16.81 (426.97)
400KV	57.97 (1472.44)	34.00 (864)	8.50 (216)	52 (1321)	16.81 (426.97)
450KV	62.94 (1598.67)	38.00 (965)	10.00 (254)	60 (1524)	20.81 (528.57)
500KV	71.31 (1811.27)	38.00 (965)	10.00 (254)	70 (1778)	20.81 (528.57)

# Driver Assembly - Master

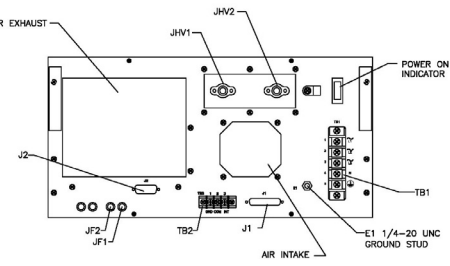
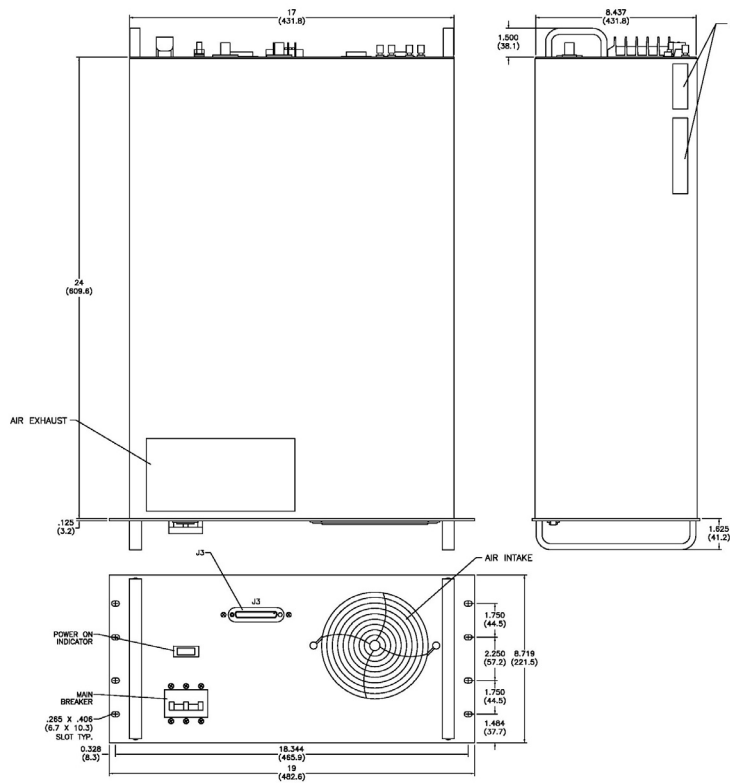

TB2 LEGEND			TB1 LEGEND		
1 GROUND	1 LINE	4 NEUTRAL (NC)	AC INPUT	208/380/415/480VAC	
2 COMMON	2 LINE	5 GROUND		+/- 10%	
3 INTERLOCK	3 LINE			48-63 HZ	3 PHASE

  

J1 LEGEND		J3 LEGEND	
1 COMMON	9 RESERVED	11 METER	13 COMMON
2 COMMON	10 V FEEDBACK -	12 +15V	14 +10V REFERENCE
3 RESERVED	11 V FEEDBACK +	13 HV ENABLE	15 HV OFF SWITCH
4 INTERLOCK	12 I FEEDBACK +	14 GROUND	16 HV ON SWITCH
5 INTERLOCK	13 I FEEDBACK -	15 +24V RETURN	17 HV ON SWITCH
6 SHIELD	14 HV RETURN	16 INTERLOCK LED	18 HV ON SWITCH
7 RESERVED	15 POLARITY	17 HV ON LED	19 HV ON SWITCH
8 ARC	16-25 RESERVED	18 +24V	20 I MODE LED
		19 V METER	21 POLARITY LED
		20 I PROGRAM	22 V MODE LED
		21 SIGNAL COMMON	23 V MONITOR
		22 V PROGRAM	24 I MONITOR

J2 LEGEND		JF1 TX-A OUTPUT	
1 SLAVE HV ON	8 POLARITY	JF2 TX-B OUTPUT	
2 SLAVE FAULT +	9 RESERVED		
3 SLAVE FAULT -	10 RESERVED		
4 RELAY +	11 V PROGRAM		
5 RELAY -	12 I FEEDBACK		
6 SLAVE ENABLE	13 I PROGRAM		
7 COMMON	14 SIGNAL COMMON		
	15 RESERVED		

IN (MM)  
NET WEIGHT: 60 POUNDS; 27kg

# Driver Assembly - Slave

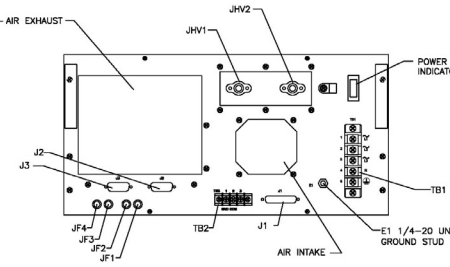
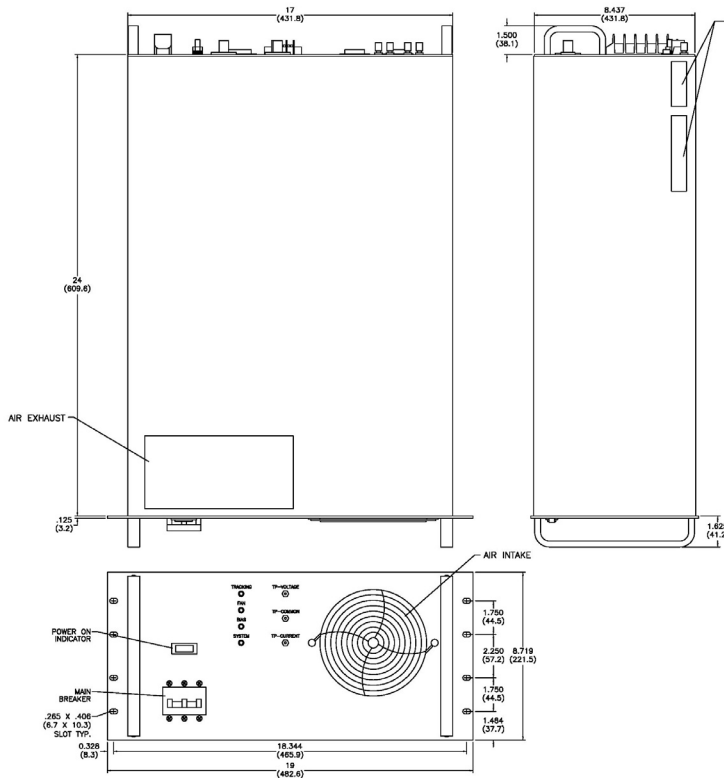

TB2 LEGEND			TB1 LEGEND		
1 GROUND	1 LINE	4 NEUTRAL (NC)	AC INPUT	208/380/415/480VAC	
2 COMMON	2 LINE	5 GROUND		+/- 10%	
3 RESERVED	3 LINE			48-63 HZ	3 PHASE

  

J1 LEGEND		J3 LEGEND	
1 COMMON	9 RESERVED	1 SLAVE HV ON	8 POLARITY
2 COMMON	10 V FEEDBACK -	2 SLAVE FAULT +	9 RESERVED
3 RESERVED	11 V FEEDBACK +	3 SLAVE FAULT -	10 RESERVED
4 INTERLOCK	12 I FEEDBACK +	4 RELAY +	11 V PROGRAM
5 INTERLOCK	13 I FEEDBACK -	5 RELAY -	12 I FEEDBACK
6 GROUND	14 HV RETURN	6 SLAVE ENABLE	13 PROGRAM
7 RESERVED	15 POLARITY	7 COMMON	14 SIG. COMMON
8 ARC	16-25 RESERVED		15 GROUND

J2 LEGEND		JHV1 - HIGH VOLTAGE OUTPUT CONNECTOR	
1 SLAVE HV ON	8 POLARITY	JHV2 - HIGH VOLTAGE OUTPUT CONNECTOR	
2 SLAVE FAULT +	9 RESERVED	J1 - HIGH VOLTAGE INTERFACE	
3 SLAVE FAULT -	10 RESERVED	J2 - SLAVE INTERFACE OUTPUT	
4 RELAY +	11 V PROGRAM	J3 - SLAVE INTERFACE INPUT	
5 RELAY -	12 I FEEDBACK	JF1 - TX-A OUTPUT	
6 SLAVE ENABLE	13 I PROGRAM	JF2 - TX-B OUTPUT	
7 COMMON	14 SIGNAL COMMON	JF3 - RX-A INPUT	
	15 RESERVED	JF4 - RX-B INPUT	
		E1 - GROUND STUD	

IN (MM)  
NET WEIGHT: 60 POUNDS; 27kg

# Remote Control Assembly

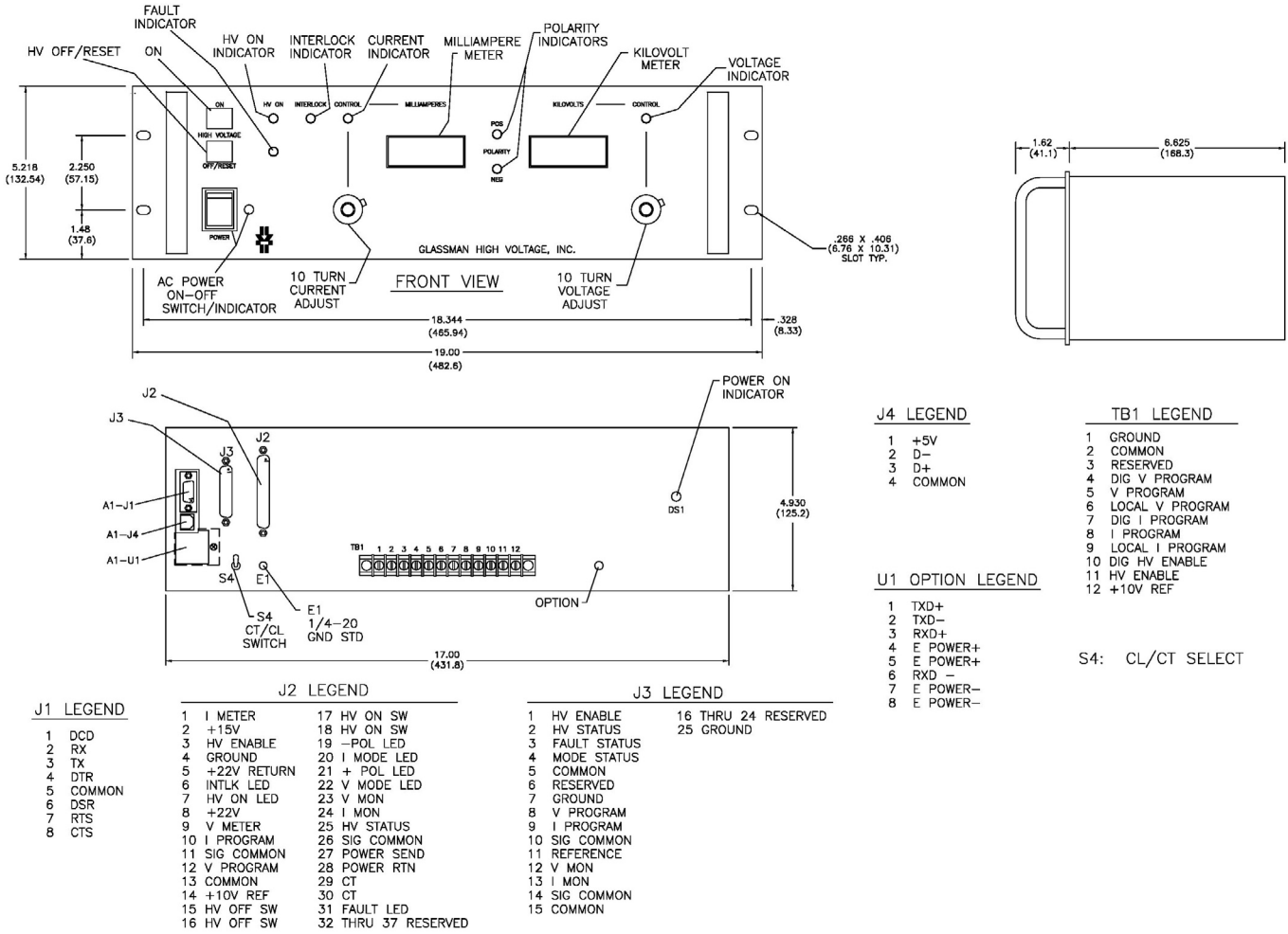

**J1 LEGEND**

1	DCD
2	RX
3	TX
4	DTR
5	COMMON
6	DSR
7	RTS
8	CTS

**J2 LEGEND**

1	I METER	17	HV ON SW
2	+15V	18	HV ON SW
3	HV ENABLE	19	-POL LED
4	GROUND	20	I MODE LED
5	+22V RETURN	21	+ POL LED
6	INTLK LED	22	V MODE LED
7	HV ON LED	23	V MON
8	+22V	24	I MON
9	V METER	25	HV STATUS
10	I PROGRAM	26	SIG COMMON
11	SIG COMMON	27	POWER SEND
12	V PROGRAM	28	POWER RTN
13	COMMON	29	CT
14	+10V REF	30	CT
15	HV OFF SW	31	FAULT LED
16	HV OFF SW	32	THRU 37 RESERVED

**J3 LEGEND**

1	HV ENABLE	16	THRU 24 RESERVED
2	HV STATUS	25	GROUND
3	FAULT STATUS		
4	MODE STATUS		
5	COMMON		
6	RESERVED		
7	GROUND		
8	V PROGRAM		
9	I PROGRAM		
10	SIG COMMON		
11	REFERENCE		
12	V MON		
13	I MON		
14	SIG COMMON		
15	COMMON		

**J4 LEGEND**

1	+5V
2	D-
3	D+
4	COMMON

**U1 OPTION LEGEND**

1	TXD+
2	TXD-
3	RXD+
4	E POWER+
5	E POWER+
6	RXD-
7	E POWER-
8	E POWER-

**TB1 LEGEND**

1	GROUND
2	COMMON
3	RESERVED
4	DIG V PROGRAM
5	V PROGRAM
6	LOCAL V PROGRAM
7	DIG I PROGRAM
8	I PROGRAM
9	LOCAL I PROGRAM
10	DIG HV ENABLE
11	HV ENABLE
12	+10V REF

S4: CL/CT SELECT

# 16 kW System

